

ÖKO-LAVAMAT 74620 update

The environmentally friendly washing machine

Instruction book



Dear Customer,

Please read this instruction book through carefully, before using the appliance.

Please ensure you fully understand the safety instructions on the first pages of this instruction book! Retain the instruction book for future reference, and pass it on to any future owners.



The warning triangle and/or the key words (**Warning!**, **Caution!**, **Important!**), emphasizes information which is important for your safety or the correct functioning of the appliance. It is essential that this information is observed.



1. This symbol guides you step by step when operating the appliance.
2. ...



This symbol gives you additional information and practical tips on using the appliance.



Tips and information about the economical and environmentally friendly use of the machine are marked with the clover symbol.

If you require assistance or advice on your appliance, please contact our customer care department by letter or telephone:

Customer Care Department
AEG Domestic Appliances Limited
P.O. Box 47
Newbury
Berkshire RG 14 5XL
Tel: 01635 572700
Fax: 01635 42970

Printed on environmentally friendly paper.
Whoever thinks ecologically also acts ecologically.

CONTENTS

Operating Instructions	6
Safety Instructions	6
Disposal	8
Environmental Tips	8
Description of the Appliance	9
Front View	9
Detergent Dispenser Drawer	9
Control Panel	10
Program Selector	10
Program Option Buttons	11
Consumption Data and Wash Times	12
What does "update" mean?	12
Before Using for the First Time	13
Preparing a Wash Load	13
Sorting and preparing a wash load	13
Washing Types and Care Symbols	14
Detergents and Conditioners	14
Which Detergent?	15
And in which form?	16
How much Detergent and Fabric Softener?	17
Using a Water Softening Agent	17
Running a Wash Cycle	18
Brief Instructions	18
Setting the Washing Program	19
Changing Spin Speed/Selecting Rinse Hold	19
Setting the Delay Timer	20
Opening and Closing the Door	20
Loading the Washing	20
Adding Detergent/Conditioner	21
Starting the Washing Program	22
Washing Program Sequence	23
Washing Cycle Complete/Removing the Washing	24

Program Tables	25
Washing	25
Separate Fabric Softening/Starching	26
Separate Rinsing	26
Separate Spinning	26
Maintenance and Cleaning	27
Control Panel	27
Detergent Dispenser Drawer	27
Washing Machine Drum	27
Door	27
What to do when...	28
Trouble Shooting	28
If the Washing Results are not Satisfactory	31
Carrying out an Emergency Emptying	32
Cleaning the Drain Pump	33
Unlocking the Door in an Emergency	34
Additional Rinse and/or Wash-Water Cooling	34
Service & Spare Parts	37
Guarantee Conditions	38

Installation and Connection Instructions	40
Installation Safety Precautions	40
Appliance Dimensions	41
Front and Side Views	41
Rear View	41
Appliance Installation	42
Appliance Transit	42
Removing Transit Packaging	43
Installation-Site Preparation	44
Levelling the Appliance	44
Electrical Connection	45
Water Connection	47
Water Pressure	47
Inlet Hose Connection	48
Water Drainage	49
Technical Data	50
AEG Service Force	50
Index	51

OPERATING INSTRUCTIONS

Safety Instructions

Your safety is of paramount importance, please ensure you read these warnings before installing or using the appliance. If you are unsure about any of the meanings of these warnings, contact the Customer Care Department.

Prior to Initial Start-up

- This appliance must be connected to the cold water supply only.
- Observe the "**Installation and Connection Instructions**" in this instruction book.
- If the appliance is delivered during the winter and temperatures are below freezing, allow the appliance to stand at room temperature for 24 hours before operation

Intended Use

- Always unplug the appliance and turn off the water supply after use.
- Only use the washing machine to wash normal domestic washing. If the washing machine is used for any other purpose or is incorrectly used, the manufacturer accepts no liability for any damages which may result.
- It is dangerous to alter the specifications or attempt to modify this product in any way.
- Only use detergents which are suitable for automatic washing machines, and follow the recommendations of the detergent manufacturer.
- Garments which have been in contact with flammable solvents should not be washed.
- Dyes and bleaching agents may only be used if specifically permitted by the manufacturer of these products. We cannot be held liable for any damages.
- Damage due to frost is not covered by the guarantee! If the washing machine is located in a room in which below freezing temperatures might occur, emergency draining must be carried out if danger of freezing occurs (see "Carrying out an emergency emptying"). In addition, the inlet hose must be disconnected from the tap, drained and laid on the floor.

Child Safety

- This appliance is designed to be operated by adults. Children should not be allowed to tamper with the controls or play with the appliance.
- Pets and children have been known to climb into washing machines. Please check the drum before use.
- Keep all packaging well away from children.
- Keep all detergents in a safe place out of childrens reach.
- When disposing of the appliance, cut off the mains cable, and destroy the plug. Disable the door catch to prevent young children being trapped inside.

General Safety

- Repairs to the washing machine may only be carried out by qualified personnel. Repairs carried out by inexperienced persons may cause injury or serious malfunctioning. Contact your local AEG Service Force Centre.
- Never operate the washing machine if the mains cable is damaged or the control panel, work top or base area are damaged allowing internal components to be accessible.
- Switch off the appliance and isolate from the mains supply before carrying out any cleaning or maintenance work!
- Do not use the mains cable to pull the plug out of the socket.
- Adaptors and extension cables must not be used. There is risk of overheating!
- During high temperature wash programs, the glass of the door may become hot. Do not touch!
- Allow the water to cool down before cleaning the drain pump, carrying out emergency emptying or opening the door in an emergency.



Disposal

Packaging

- Dispose of the packaging material correctly. All packaging materials are environmentally friendly and can be disposed of without any danger to the environment.
- The external plastic covering and bags inside are made of polyethylene (marking >PE<).
- The padding is made of CFC free expanded polystyrene (marking >PS<).

Washing Machine

When disposing of the washing machine:

- Cut off the mains cable and destroy the plug
- Disable the door catch to prevent young children becoming trapped inside.
- Use an authorised disposal site.



Environmental Tips

To save water, energy and to help protect the environment, we recommend that you follow these tips:



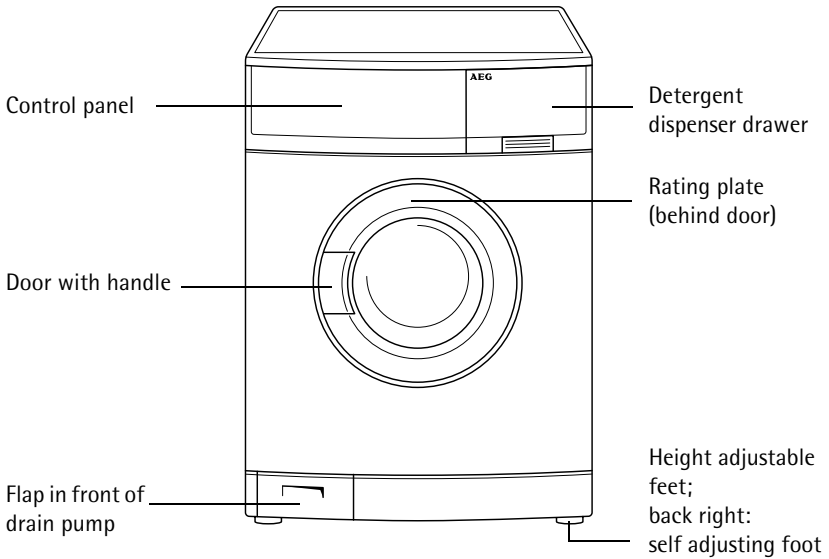

- Do not use a prewash for normally soiled washing.
- It is more economical to wash full loads.
- When washing small loads reduce the detergent by half to two thirds.
- Pre-treat stains, and then wash at a lower temperature.
- Use the energy saving program when washing light to normally soiled garments.

Description of the Appliance

Front View



Detergent Dispenser Drawer

-  Pre wash detergent/ soaking agent or water softening agent if used.
-  Main wash detergent in powder form and water softening agent if required
-  Stain remover
-  Liquid conditioners (fabric softener, starch)

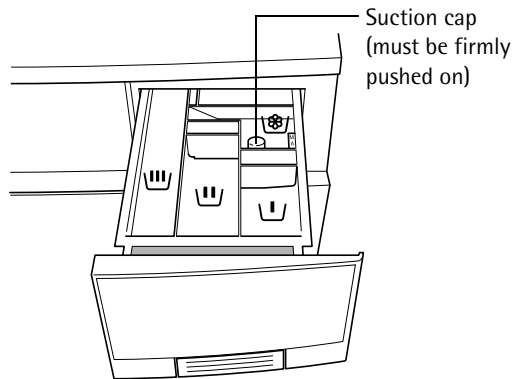

Control Panel

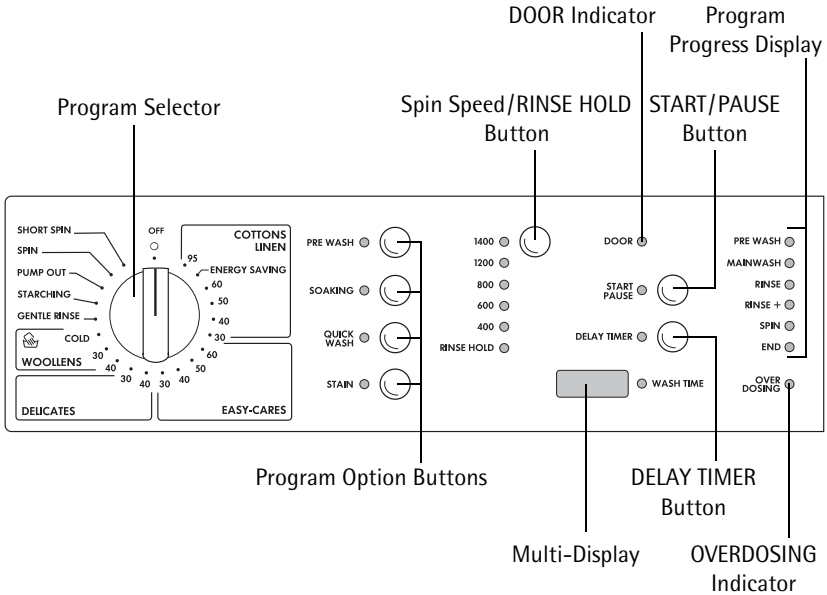

Program Selector

The program selector defines the nature of the washing cycle (e.g. water level, drum movement, number of rinses, spin speed) to suit the type of washing, as well as the wash temperature.

OFF

Switches the washing machine off, the machine is switched on at all other positions.

COTTONS/LINEN

Main washing cycle for cottons/linen at 30° C to 95° C.



ENERGY SAVING position: Energy saving program at approx. 67° C for lightly to normally soiled cottons, extended washing time (cannot be combined with QUICK WASH and STAIN).

EASY-CARES

Main washing cycle for easy-care fabrics at 30° C to 60° C.

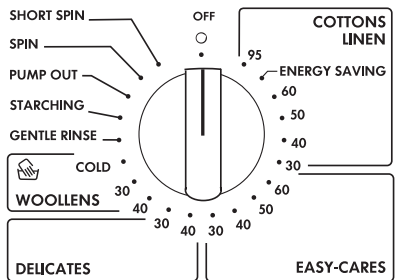

DELICATES

Main washing cycle for delicates at 30° C or 40° C.

WOOLLENS /  (Hand Washing)

Main washing cycle (cold to 40° C) for machine washable woollens as well as for hand washable woollen fabrics and silk with the  (hand washing) care symbol.

GENTLE RINSE

Separate gentle rinse, e.g. for rinsing hand washed fabrics (2 rinses and a short spin).

STARCHING

Separate starching, separate softening, separate conditioning of wet washing (1 rinse, liquid conditioner is washed in from the  compartment, and a spin).

PUMP OUT

Pump out the water at the end of a rinse hold (without spinning).

SPIN

Pump out the water at the end of a rinse hold and spin, or separate spinning of hand washed cottons/linen.

SHORT SPIN

Pump out the water at the end of a rinse hold and short spin, or separate short spinning of delicate fabrics (easy-cares, delicates, woollens).

Program Option Buttons

The program option buttons are used to adapt the washing program to suit the degree of soiling of the washing. program options are not required for normally soiled washing.

The different functions can be combined together depending on the program.

PRE WASH

Cold pre wash prior to the subsequent main washing cycle that follows automatically.

SOAKING

Approx. 1 hour at 40° C. Can be lengthened to a maximum of 19 hours using the DELAY TIMER button. The main washing program then follows automatically.



QUICK WASH

Shortened main washing cycle for lightly soiled washing.

STAIN

For treating heavily soiled or stained washing. (In-wash stain treatment is washed in from the  compartment at the optimal point in the program cycle.)



When the WOOLLENS/ (hand washing) setting is chosen, the program options cannot be selected (any buttons pressed do not have any effect).

Consumption Data and Wash Times

The values given in the following table for selected programs were calculated under standard conditions. They provide a useful guide for operation in the home.

Program Selector/Temperature	Load in kg	Water in Litres	Energy in kWh	Time in Minutes
COTTONS/LINEN 95	5	42	1.70	130
COTTONS/LINEN 60 ¹⁾	5	42	0.94	119
COTTONS/LINEN 40	5	42	0.60	109
EASY-CARES 40	2.5	54	0.50	82
DELICATES 30	2.5	48	0.35	65
WOOLLENS /  (Hand Washing) 30	1	53	0.28	37

1) **Note:** program setting for testing in accordance with EN 60 456

What does "update" mean?

The control system of your machine is fully electronic. The software which determines this control system can be reprogrammed. If a state of the art in washing technology is reached, your machine can be updated.

The cost of the update will be advised at the time of the request. For further information regarding this please contact the AEG Customer Care Department.

Before Using for the First Time

-  1. Pull the detergent dispenser drawer out a short distance.
2. Pour about 1 litre of water through the detergent dispenser drawer into the washing machine. When this has been done, the ÖKO lock can function correctly.
3. Run a washing cycle without washing (COTTONS 95, with half the amount of washing powder).
This removes any residues from the drum which may have been left during manufacture.

Preparing a Wash Load

Sorting and preparing a wash load

- Sort washing according to care symbol and type (see "Washing types and care symbols").
- Empty all pockets.
- Remove metal objects (paper clips, safety pins etc.).
- In order to prevent bunching up of washing and damage to washing, close zippers, button up duvets and pillow cases, and tie up loose straps such as from aprons.
- Turn articles with double layered textiles inside out (sleeping bags, anoraks etc.).
- Coloured, knitted fabrics, as well as wool and textiles with appliqués should be turned inside out.
- Place small and delicate articles (socks, tights, bras, etc.) into a washing net or a pillow case.
- Handle curtains with care. Remove metal strips or plastic hooks.
- Do not wash coloured and white washing together. White washing will otherwise turn grey.
- New, coloured washing often contains excessive dye. Wash these items separately the first time.
- Mix small and large articles of washing! This improves washing efficiency, and the washing is more evenly distributed during the spin cycle.

- Shake out washing before placing into the washing machine.
- Do not place folded washing into the drum.
- Observe tips such as "wash separately" and "wash separately several times"!

Washing Types and Care Symbols

Care symbols assist in the selection of the correct washing program. Washing should be sorted according to type and care symbol. The temperatures indicated in the care symbols are maximum temperatures.

Cottons

Textiles made from cotton and linen with this care symbol will withstand maximum wash actions and high temperatures.

The COTTONS/LINEN program is appropriate for this type of washing.

Linens

Textiles made from cotton and linen with these care symbols will withstand maximum wash actions and high temperatures.

The COTTONS/LINEN program is appropriate for this type of washing.

Easy-care washing

Fabrics such as treated cottons, cotton mixtures and synthetics with this care symbol need a softer washing action.

The EASY-CARES program is suitable for this type of washing.

Delicates

Fabrics such as those with layered fibres, micro-fibres, as well as synthetics and net curtains with this care symbol require particularly careful handling. The DELICATES program is suitable for this type of washing.

Wool and particularly delicate washing

Textiles such as wool, wool mixtures and silk with these care symbols require a very gentle wash cycle. The WOOLLENS/ (Hand washing) program is appropriate for this type of washing.

Important! Fabrics with this care symbol  (Do Not Wash!) must not be washed in the washing machine!

Detergents and Conditioners

Only use detergents and fabric softeners suitable for automatic washing machines. As a general rule follow the instructions of the detergent manufacturers.

Which Detergent?

To ensure you obtain the best wash results from your appliance, it is important to use the right detergent in your everyday wash, and only detergents recommended for use in automatic machines.

To maintain the appearance of your clothes and household textiles and to make them last longer you should use different types of detergent for different washes whether for whites, colours or delicates.

Whites

We recommend the Ariel product range which is biological and designed to provide excellent cleaning and stain removal even at lower temperatures.



Non Biological

If you prefer to use a non biological detergent, which does not contain enzymes we recommend Fairy. Fairy provides good cleaning and stain removal.



Coloureds

For coloured items, you should use a detergent which is designed to clean while maintaining the original colour. Ariel Color does not contain bleach and therefore helps to preserve colours.



Delicate Items

When washing delicates, such as wool, you should use a product which is specially designed to care for fine fabrics. Dreft Automatic is suitable for woollens and other delicates.



Laundry Bleach

For additional stain removal you may wish to use a product such as Ace Gentle Bleach, which is used in addition to your chosen detergent. Ace is suitable for all washable fabrics including coloureds.



And in which form?

Not only are there different types of detergent, but they are also available in different forms. Whether you choose a powder or liquid in traditional or compact form, is down to personal choice.

Traditional Powders

Pour the powder directly into the dispenser drawer. Do not sprinkle powder onto clothes in the machine drum.

Liquids

Measure the detergent into the specially designed dosing device* which should be placed on top of the laundry, and at the back of the machine drum.

Compact

Compact detergents (or concentrates as they are also known) are available in liquid or powder form, and generally require a smaller dosage. Follow the manufacturer's instructions to ensure the most economical usage. Pour the detergent directly into the dispenser drawer, or alternatively measure the detergent into the specially designed dosing device* which should be placed on top of the laundry, and at the back of the machine drum.

***If you use a dosing device/ball in a washer dryer, please ensure the device/ball is removed before carrying out a drying programme.**

Fabric Conditioners

These are ideal for improving „softness“, and also reduce static cling on synthetics and make ironing easier. They are available in two types:

For example Lenor liquid fabric softener, for use in the **washing machine/washer dryer**. The liquid fabric softener should be poured into the compartment marked with the symbol . Follow the manufacturer's dosage instructions and never exceed the MAX level.



Bounce conditioning sheets for use in a **tumble dryer**. We recommend the conditioning sheets are pinned (using a safety pin) to an article of laundry and placed in the tumble dryer.



How much Detergent and Fabric Softener?

The amount to be used depends on

- the load:



If the detergent manufacturer does not make any specifications for small loads, use a third less for half loads, and for very small loads only use half of the amount of washing powder recommended for a full load.

- the soiling:

For only lightly soiled washing use less washing powder. Follow the instructions of the detergent manufacturer.

- the water hardness:

The harder the water, the higher the dosage! You will find the quantities to use according to water hardness on the detergent packet.

Using a Water Softening Agent

In hard water areas, the use of a water softening agent can reduce the amount of detergent necessary. See manufacturers recommendations.

Running a Wash Cycle

Brief Instructions

A washing cycle consists of the following steps:

1. Set the correct washing program:
 - select the program and the temperature with the program selector
 - select any program options if required
2. If necessary change the spin speed/select RINSE HOLD).
3. Set time delay if required.
4. Open the door, load the washing.
5. Shut the door.
6. Add detergent/conditioner.
7. Start washing program.

When the Washing Program has Finished:

Important! If the washing cycle ended with rinse hold, carry out a PUMP OUT, SPIN or SHORT SPIN before opening the door.

8. Open the door, remove the washing.
9. Set the program selector to OFF.
10. Close the water tap.

We recommend you unplug the appliance and turn off the water supply when the washing program has finished.

Setting the Washing Program

i See "Program Tables" for a suitable program, correct temperature and possible additional programs to suit the type of washing.

☞ Set the program selector to the desired program and the desired temperature. The expected duration of the program selected is displayed on the multi-display in minutes.

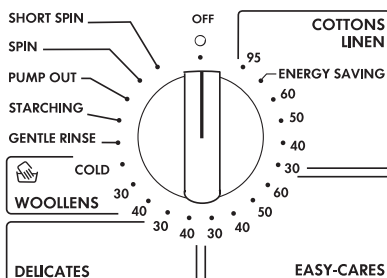

☞ If required select program option(s):
The indicator of the program option selected lights up.
– To change the selection press another button.
– To cancel a selection, press the button again.



Changing Spin Speed/Selecting Rinse Hold

☞ If necessary change the spin speed for the final spin/ select rinse hold: press the spin speed/RINSE HOLD button repeatedly until the indicator of the required spin speed or RINSE HOLD illuminates.

With RINSE HOLD the washing stays in the final rinse water.

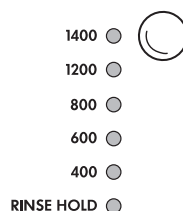

i If you do not change the spin speed, the final spin will be automatically adjusted to suit the washing program:

- COTTONS/LINEN 1400 revolutions per minute
- EASY-CARES 1200 revolutions per minute
- DELICATES 1200 revolutions per minute
- WOOLLENS/**☞** (Hand Washing) 1200 revolutions per minute

The speed for the intermediate spin is dependent on the program selected and cannot be changed.

Setting the Delay Timer

- ☞ If necessary set the delay timer:
press the DELAY TIMER button repeatedly until the desired time delay is displayed in the multi-display, for example **12h** for a 12 hour delay start of the program.

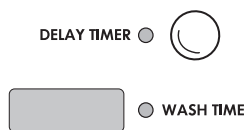

- i** If **19h** is displayed and you press the button again, the duration of the washing program set appears (displayed in minutes, e.g. **119**). In this condition the start delay timer is not set.

If the SOAKING option is selected the delay timer determines the soaking time. (Without delay timer the soaking time is approx. 1 hour.)

Opening and Closing the Door

- ☞ Opening: pull the handle on the door.
- ☞ Closing: press the door firmly

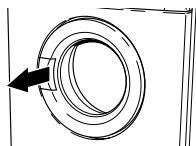

When the appliance is switched on, the DOOR indicator shows whether the door can be opened:

- green light = door can be opened
- light off = door cannot be opened at the moment
- red light = door is open

DOOR ●

Loading the Washing

- i** See "Program Tables" for maximum loads.
For information about the correct preparation of the washing see "Washing Types and Care Symbols".

- ☞ **1.** Sort and prepare washing according to type.
- 2.** Open the door: pull the handle on the door.
- 3.** Load the washing.

Important! Do not trap any washing when closing the door! The fabrics and the machine could be damaged!

- 4.** Close the door firmly.

Adding Detergent/Conditioner

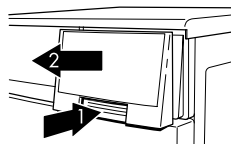

 For instructions concerning detergents and conditioners see "Detergents and Conditioners".

-  1. Open the detergent dispenser drawer: press in the flap on the drawer so as to be able to grasp the handle (1), pull out the drawer (2).



2. Add detergent/conditioner.

 Pre-wash detergent/detergent for soaking (for program options PRE WASH/SOAKING), or water softening agent.

 Main wash detergent in powder form (if you use a water softening agent and need compartment  for the pre-wash/soaking detergent, add the softening agent to the detergent in compartment .)

 Stain remover (only for STAIN action phase)

 Liquid conditioners (fabric softener, starch)

Important: Do not fill above the MAX mark. When using thick concentrated fabric conditioners and starches we recommend you dilute the concentrate with water to ensure trouble-free dispensing. If using starch powder dissolve according to manufacturers instructions.

3. Push the detergent dispenser drawer right in.

When using Liquid Detergents:

Add liquid detergent with dosing containers provided by the detergent manufacturer. Observe instructions on detergent package.

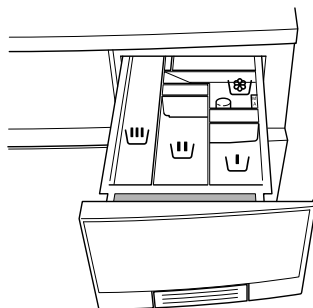

Starting the Washing Program

 1. Check whether the water tap is open.

2. Start the washing program: press the START/PAUSE button.



The washing program is started, or starts at the end of the time delay set.



If the DOOR indicator flashes red when the START/PAUSE button is pressed, the door is not properly closed. Close the door firmly and press the START/PAUSE button again.

If the delay timer has been set:

The start time delay set on the delay timer counts down; the time remaining until the program starts is displayed on the multi-display (in whole hours remaining). During this time you can add washing, change or stop the delay timer.

- Adding washing: press the START/PAUSE button, the door can be opened. Then close the door and press the START/PAUSE button again.
- Changing or stopping delay timer: press the DELAY TIMER button repeatedly until the desired time is displayed; when the program duration is displayed (display in minutes, e.g. 1:19), the washing program starts without delay.

Washing Program Sequence

Program Progress Display

Prior to the start, the program steps chosen are displayed on the program progress display. During the washing program, the current program step is displayed.



Multi-Display

The expected time remaining (in minutes) to the end of the program is displayed on the multi-display.



Counting down of the remaining time may be stopped or corrected by the washing machine controller as a result of automatic adjustments to the program (amount of washing, washing type, imbalance detection, special rinse cycle, etc.).

Changing the Spin Speed

The spin speed can be changed or RINSE HOLD set during the washing program. Other settings cannot be altered.

Stopping the Program



To stop the washing program early turn the program selector to OFF.





The washing program can be interrupted at any time using the START/PAUSE button and then continued by pressing the button again. It is not possible to change the washing program during a pause.

Washing Cycle Complete/Removing the Washing

Once the washing program has come to an end, END illuminates on the program progress display.

If RINSE HOLD was selected, the indicator beside the START/PAUSE button flashes.

-  **1.** After a RINSE HOLD, the water must first be pumped out:
 - Press either the START/PAUSE button (the washing will be spun in accordance with the program which has just been completed; the spin speed can also be changed during spinning using the spin speed/RINSE HOLD button),
or
 - turn the program selector to (PUMP OUT), and press the START/PAUSE button (the water is pumped out without spinning),
or
 - turn the program selector to SPIN or SHORT SPIN, and press the START/PAUSE button (the washing will be spun or short spun).At the end of this program step, the END indicator will illuminate.
- 2.** Open the door.
As soon as the DOOR indicator is green, the door can be opened.
- 3.** Turn the program selector to OFF.
- 4.** Remove the washing.
- 5.** Close the water tap.
- 6.** Pull the detergent drawer out a little after washing so that it can dry out. Leave the door ajar so that air can circulate in the washing machine.











 If the OVERDOSING indicator illuminates, then too much detergent was used in the washing program just completed, and as a result an additional rinse performed. Next time you use the machine, observe the detergent manufacturer's dosing instructions for the load to be washed!

Important! If the washing machine is not to be used for a long period: close the tap and isolate the washing machine from the mains.

Program Tables

Washing

Not all possible settings are given in the following, but only those that are useful and meaningful in everyday use.

Type of Washing, Care Symbol	Max. Load (Weight Dry) ¹⁾	Program Selector Temperature	Possible Option Buttons
Cottons 	5 kg	COTTONS/LINEN 95	PRE WASH
			SOAKING
			QUICK WASH
			STAIN
Energy Saving Program Cottons 	5 kg	COTTONS/LINEN ENERGY SAVING	PRE WASH
			SOAKING
Linen  	5 kg	COTTONS/LINEN 30 to 60	PRE WASH
			SOAKING
			QUICK WASH
			STAIN
Easy-Cares   	2.5 kg	EASY-CARES 30 to 60	PRE WASH
			SOAKING
			QUICK WASH
			STAIN
Delicates 	2.5 kg (or 15-20m ² Net Curtains)	DELICATES 30, 40	PRE WASH
			SOAKING
			QUICK WASH
			STAIN
Woolens/Hand Washing   	1 kg	 WOOLLENS COLD to 40	

1) A 10-litre bucket contains about 2.5 kg of dry washing (cotton).

Separate Fabric Softening/Starching

Type of Washing	Max. Load (Weight Dry)	Program Selector
Cottons/Linen	5 kg	STARCHING
Easy-Cares	2.5kg	
Delicates	2.5kg	

Separate Rinsing

Type of Washing	Max. Load (Weight Dry)	Program Selector
Cottons/Linen	5 kg	GENTLE RINSE
Easy-Cares	2.5kg	
Delicates	2.5kg	
Woollens/Hand Washing	1 kg	

Separate Spinning

Type of Washing	Max. Load (Weight Dry)	Program Selector
Cottons/Linen	5 kg	SPIN
Easy-Cares	2.5kg	SHORT SPIN
Delicates	2.5kg	
Woollens/Hand Washing	1 kg	

Maintenance and Cleaning

Control Panel

Important! Do not use household furniture polish or abrasive cleaners to clean the panel and operating parts.

- ☞ Wipe over the operating panel with a damp cloth. Use warm water.

Detergent Dispenser Drawer

The detergent dispenser drawer should be cleaned from time to time.

- ☞ 1. Pull the detergent dispenser drawer out as far as it will go.
- 2. Remove the detergent dispenser drawer by pulling sharply.
- 3. Remove the suction cap.
- 4. Clean the suction cap under running water.
- 5. Clean the separate compartments with warm water. A bottle brush is a useful aid.
- 6. Push on the suction cap firmly so that it is sitting tightly.
- 7. Clean the entire compartment area of the washing machine with a brush.
- 8. Set the detergent dispenser drawer into the guide tracks and push in.

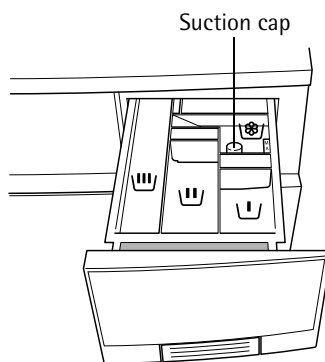

Washing Machine Drum

The washing machine drum is made from rust-free stainless steel. Any objects left in the laundry which are likely to rust can stain the drum.

Important! Do not clean the stainless steel drum with descaling agents containing acids, scouring agents containing chlorine or iron or steel wool. AEG Service Force Centre has suitable agents available. (Part no: 899 646 401 5214)

- ☞ Remove rust stains on the drum with a stainless steel cleaning agent.

Door

- ☞ Regularly check if there are deposits or foreign bodies in the rubber seal behind the door and remove them.

What to do when...

i The whistling noise when spinning may be different to your previous washing machine which is due to the modern drive system.



Trouble Shooting

If you call out an engineer and the fault is listed here, a charge is levied even if the appliance is in guarantee.

- If the error code **E1** or **E2** is displayed in the multi-display, check the troubleshooting guide below before calling an engineer:
 Display **E1** "No water flows in ...".
 Display **E2** "Washing has not been spun sufficiently, ...".
 After eliminating the error, press the **START/PAUSE** button. If the error code is displayed again, please contact your local AEG Service Force Centre
- For all other errors displayed in the multi-display, please contact your local AEG Service Force Centre, stating the error code.

Malfunction	Possible Cause	Remedy
Washing machine does not work.	Mains plug is not plugged in.	Insert mains plug.
	House fuse is defective.	Replace fuse.
	Door is not closed properly.	Close door; lock must engage audibly.
	START/PAUSE button not pressed for long enough.	Keep START/PAUSE button pressed until the program starts.
No water flows in. Error code E1 appears.	Tap is closed.	Open tap.
	Filter in the threaded fitting on the water inlet hose is blocked.	Unscrew the hose from the tap, remove the filter and clean under running water.

Malfunction	Possible Cause	Remedy
Washing machine vibrates during operation or is unstable.	The machine is not level.	Adjust the feet according to the installation and connection instruction.
	There is only very little washing in the machine (e.g. only a bath robe).	Does not impair function.
	Water could not be completely pumped out prior to spinning because the drain hose is kinked or the drain pump is blocked.	Check the drain hose and if necessary remove any kink or clean the drain pump and remove any foreign bodies from the pump housing.
Excessive foaming during the main wash	Probably too much detergent was used.	It may be necessary to reduce the amount of detergent used. Follow the detergent manufacturer's recommendations.
Water runs out from under the washing machine.	Threaded fitting on the water inlet hose is leaking.	Tighten the inlet hose connections.
	The inlet hose has a leak.	Check the inlet hose and if necessary replace it.
	The drain pump cover is not tight.	Tighten cover by turning clockwise.
Washing is caught in the door.	Washing is caught in the door.	Stop the program, remove the washing caught in the door, start a new program.
Fabric softener is not added, compartment  for fabric softener is filled with water.	Suction cap in the fabric softener compartment is not correctly fitted or is blocked.	Clean detergent dispenser drawer, place suction cap firmly in position.

Malfunction	Possible Cause	Remedy
Washing has not been spun sufficiently, there is water left in the drum. Error code E2 appears.	Drain hose is kinked.	Remove kink.
	Drain hose too high.	Check installation instructions.
	Drain pump is blocked.	Switch off the machine and pull the plug out of the socket. Carry out emergency emptying (see "Carrying out an Emergency Emptying"). Clean the drain pump.
	The water drainage system is blocked.	Clean the blockage.
Door cannot be opened when the machine is switched off.	The door is locked due to safety reasons (DOOR indicator is off).	Wait until the DOOR indicator is green.
Remnants of detergent are building up in the detergent dispenser drawer.	Water tap is not fully open.	Open the water tap fully.
	The inlet hose filter in the coupling of the inlet hose at the tap is blocked.	Clean filter.
	The inlet valve filter in the coupling of the inlet hose at the appliance is blocked..	Clean filter.
Rinse water is cloudy.	The cause is probably a detergent with a high silicate content.	No negative impact on the rinsing results, possibly use liquid detergent.
When pressing a program option button the corresponding display does not light up	The program option selected is not available with the program set.	Make another selection.

If the Washing Results are not Satisfactory

If the washing turns greyish and limescale deposits are present in the drum

- Insufficient washing powder has been added.
- Incorrect washing powder was used.
- Stains were not pretreated.
- Program or temperature was not set correctly.
- When using modular washing powders the individual components were not used in the correct ratio.

If there are still grey stains on the washing

- Washing soiled with ointments, grease or oils was washed with insufficient washing powder.
- The temperature selected for the wash was too low.
- A frequent cause is that fabric softener especially a concentrated one has come into contact with the washing. Wash out these types of stains as fast as possible and use the fabric softener carefully.

If after the final rinse foam is still visible

- Modern washing powders can still cause foam in the final rinse cycle. The washing is nevertheless sufficiently rinsed.

If there are white residues on the washing

- These are insoluble contents of modern washing powders. They are not the result of an insufficient rinse. Shake out the washing or brush it off. Turn the washing inside out before washing it. Review your choice of powder, possibly use liquid detergents.

Carrying out an Emergency Emptying

- If the washing machine no longer pumps out the water an emergency emptying must be carried out.
- If the washing machine is located in a room in which below freezing temperatures might occur, emergency emptying must be carried out if danger of freezing occurs.
Furthermore, the inlet hose must be disconnected from the tap, drained and laid on the floor.



Warning! Switch the washing machine off and pull the mains plug prior to emergency draining.

Warning! The water, which flows out of the emergency emptying hose can be hot. First allow the water to cool down before emergency emptying!

-  **1.** Have a flat container on hand to catch the water running out.
- 2.** Pull down the flap in the left corner of the base strip (1) and remove it (2).

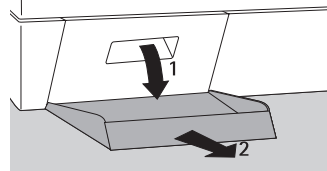

- 3.** Remove the emergency emptying hose from its holder.

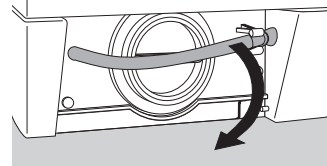

- 4.** Pull the emergency emptying hose out a little.
- 5.** Place the container under the hose.

- 6.** Undo and remove the plug in the end of the emergency emptying hose by turning it anti-clockwise (1) and pull it out (2).

The wash-water runs out. Depending upon the amount of water, it may be necessary to empty the container several times. Temporarily close the emergency emptying hose with the plug.

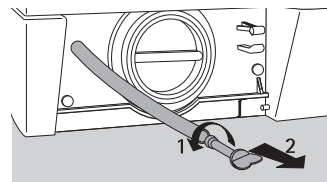

When the Water is Completely Drained:

7. Push and twist the plug firmly back into the emergency emptying hose.
8. Push the emergency emptying hose back in a little and let it catch on to the holder.
9. Put on the flap and close.



The ÖKO lock does not function when the machine has been fully emptied. Therefore add approx. 1 litre of water before the next wash (pour in through the detergent dispenser drawer).

Cleaning the Drain Pump

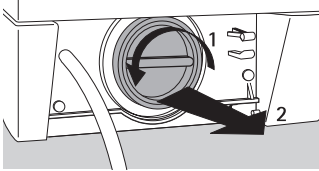
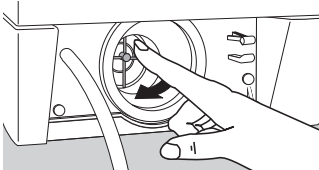
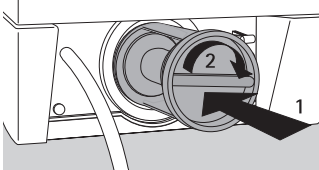

Warning! Switch off the washing machine and pull the mains plug out before cleaning the drain pump!

1. First carry out an emergency emptying (see section "Carrying out an emergency emptying").
 2. Place a towel on the floor in front of the cover of the drain pump. Surplus water may flow out.
 3. Unscrew the cover of the drain pump by twisting it anti-clockwise (1) and pull it out (2).
- 
4. Remove any foreign bodies which may be in the pump housing.
 5. Check whether the impeller of the pump can be turned. (It is normal for the pump to turn in steps.) If the impeller cannot be turned at all please contact your local AEG Service Force Centre.
- 
6. Replace the cover (1) (insert the ridges on the cover into the guiding slots) and screw on tightly in a clockwise direction (2).
 7. Close emergency emptying hose, push in and fix in place.
 8. Close the flap.
- 

Unlocking the Door in an Emergency

If the door cannot be opened (e.g. due to a faulty door lock or due to a power cut during the washing program), it can be opened using the emergency unlock feature.

1. If water can be seen in the window of the door first carry out an emergency emptying (see section "Carrying out an emergency emptying").
2. Turn the knob anti-clockwise with the help of a coin or a screwdriver.
3. Open the door by pulling on the door handle.

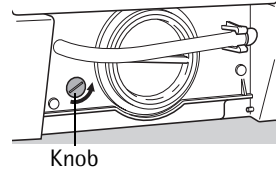

Additional Rinse and/or Wash-Water Cooling

The washing machine is on a very economical water consumption setting.

- For people who suffer from an allergy to detergents, it may be helpful to rinse with extra water (additional rinse).
- The wash-water can be cooled down before being pumped out at the end of the main wash (by adding cold water). This reduces thermal shock to fabrics, helping to prevent creasing.

i The program duration and water consumption are increased by wash-water cooling and/or the additional rinse.

Additional Rinse (RINSE+)

i If this function is set an additional rinse is performed for the programs COTTONS/LINEN, EASY-CARES and DELICATES. As supplied from the factory, the additional rinse function is not set.

Setting the Additional Rinse Function:

1. Turn the program selector to SHORT SPIN.
2. Press the SOAKING button for at least 5 seconds.
After the button has been kept pressed for 5 seconds, RINSE+ flashes on the program progress display for 5 seconds.
3. Whilst RINSE+ is flashing, release the SOAKING button.
The additional rinse function is set once the flashing has ceased. It continues to be set until specifically disabled.

When the additional rinse function is selected, the RINSE+ indicator on the program progress display illuminates prior to program start and during the additional rinse.

4. If you wish to check whether the additional rinse function is selected:
 - Turn the program selector to SHORT SPIN.
 - Press the SOAKING button briefly.

If RINSE+ flashes on the program progress display, the additional rinse function is set.

Disabling the Additional Rinse Function:

-  1. Turn the program selector to SHORT SPIN.
2. Press the SOAKING button for at least 5 seconds.
As soon as the button is pressed RINSE+ flashes on the program progress display. After 5 seconds RINSE+ ceases to flash and illuminates continuously for a further 5 seconds.
3. Whilst RINSE+ is continuously illuminated, release the SOAKING button.
Once RINSE+ has ceased to illuminate, the additional rinse function is disabled.

Wash-Water Cooling



The water is cooled prior to pumping out at the end of the main wash (by adding cold water). This setting is only effective for COTTON/LINEN at a temperature of over 40° C.)

Wash-water cooling is not selected upon delivery from the factory.

Select Wash-Water Cooling:

-  1. Turn the program selector to SHORT SPIN.
2. Press the PRE WASH button for at least 5 seconds.
After the button has been kept pressed for 5 seconds, MAINWASH flashes on the program progress display for 5 seconds.
3. Whilst MAINWASH is flashing, release the PRE WASH button.
After blinking has stopped, wash-water cooling is selected. It remains functional until it is deleted.
4. If you want to check and see if wash-water cooling has been selected:
 - Turn the program selector to SHORT SPIN.
 - Press the PRE WASH button briefly.
 If MAINWASH flashes on the program progress display, the wash-water cooling function is set.

Switching off Wash-Water Cooling:

1. Turn the program selector to SHORT SPIN.
2. Press the PRE WASH button for at least 5 seconds.
As soon as the button is pressed MAINWASH flashes on the program progress display. After 5 seconds MAINWASH ceases to flash and illuminates continuously for 5 seconds.
3. Whilst MAINWASH is continuously illuminated, release the PRE WASH button.
Once MAINWASH has ceased to illuminate, the wash-water cooling function is disabled.

Additional Rinse and Wash-Water Cooling

The additional rinse and wash-water cooling functions can be combined. Set as described in "Additional rinse" and "Wash-water cooling".

GUARANTEE CONDITIONS

Guarantee Conditions

AEG offer the following guarantee to the first purchaser of this appliance.

1. The guarantee is valid for 12 months commencing when the appliance is handed over to the first retail purchaser, which must be verified by purchase invoice or similar documentation.

The guarantee does not cover commercial use.

2. The guarantee covers all parts or components which fail due to faulty workmanship or faulty materials. The guarantee does not cover appliances where defects or poor performance are due to misuse, accidental damage, neglect, faulty installation, unauthorised modification or attempted repair, commercial use or failure to observe requirements and recommendations set out in the instruction book.

This guarantee does not cover such parts as light bulbs, removable glassware, dust bags or filters.

3. Should guarantee repairs be necessary the purchaser must inform the nearest customer service office (manufacturer's service or authorised agent). AEG reserves the right to stipulate the place of the repair (i. e. the customer's home, place of installation or AEG workshop).
4. The guarantee or free replacement includes both labour and materials.
5. Repairs carried out under guarantee do not extend the guarantee period for the appliance. Parts removed during guarantee repairs become the property of AEG.
6. The purchaser's statutory rights are not affected by this guarantee.

European Guarantee

If you should move to another country within Europe then your guarantee moves with you to your new home subject to the following qualifications:

- The guarantee starts from the date you first purchased your product.
- The guarantee is for the same period and to the same extent for labour and parts as exist in the new country of use for this brand or range of products.
- This guarantee relates to you and cannot be transferred to another user.
- Your new home is within the European Community (EC) or European Free Trade Area.
- The product is installed and used in accordance with our instructions and is only used domestically, i. e. a normal household.
- The product is installed taking into account regulations in your new country.

Before you move please contact your nearest Customer Care Centre, listed below, to give them details of your new home. They will then ensure that the local Service Organisation is aware of your move and able to look after you and your appliances.

France	Senlis	+33 (0) 44 62 29 29
Germany	Nürnberg	+49 (0) 911 323 2600
Italy	Pordenone	+39 (0) 1678 47053
Sweden	Stockholm	+46 (0) 8 738 7910
UK	Newbury	+44 (0) 1635 572700

INSTALLATION AND CONNECTION INSTRUCTIONS

Installation Safety Precautions

- This appliance is heavy, care should be taken when moving it.
- When moving, do not tip the washing machine onto its front or left hand side (viewed from the front). This is to prevent the possibility of electrical components becoming wet.
- Before installation inspect the machine for transport damage. Do not connect the appliance if it is damaged – contact your retailer.
- Ensure all packaging and transit bolts/bar have been removed, see "Removing of Transit Packaging". Failure to remove packaging and transit bolt/bar may cause serious damage to the product or property.
- Any plumbing work required to install this appliance should be carried out by a qualified plumber or competent person.
- Any electrical work required to install this appliance should be carried out by a qualified electrician or competent person.
- Check the electricity supply is the same as that indicated on the rating plate of the appliance.
- Should the appliance mains cable need to be adapted for any reason this should only be carried out by a qualified/competent person.
- In the case of a permanent connection it is necessary that you install a double pole switch between the appliance and the electricity supply (mains), with a minimum gap of 3 mm between the switch contacts and of a type suitable for the required load in compliance with the electrical regulations.
- The switch must not break the yellow and green earth cable at any point.
- Care must be taken to ensure that the appliance does not stand on the electrical supply cable.
- The installation must comply with local water authority and building regulations requirements.
- Appliances designed for cold water connection must not be connected to hot water.

Appliance Dimensions

Front and Side Views

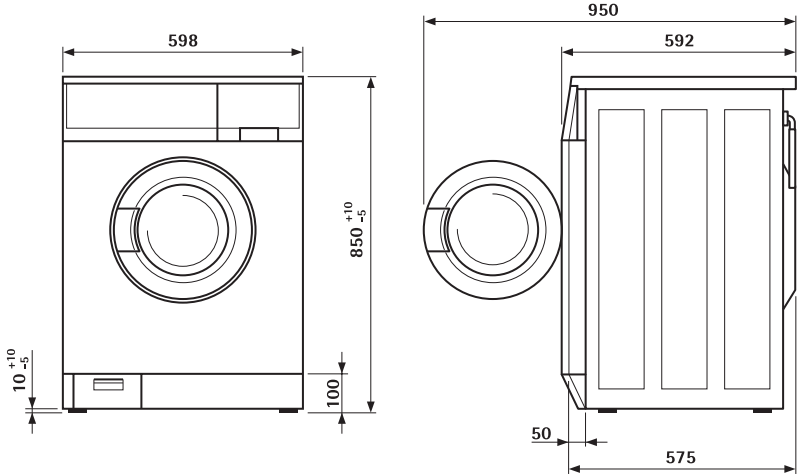

Rear View

Important! This appliance must be connected to the cold water supply only.

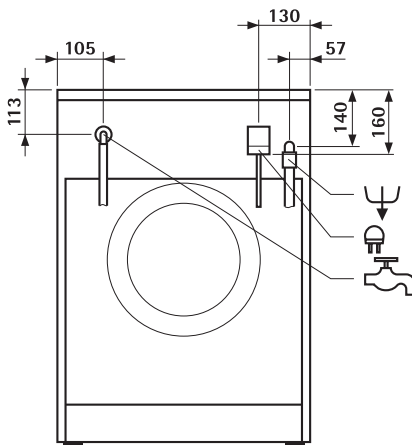

Appliance Installation

- i** The appliance worktop must not be removed to gain a height reduction when installing under a kitchen worktop.

Appliance Transit

- To prevent electrical components becoming wet when moving the appliance, do not tip the washing machine onto its front or the left hand side (viewed from the front).
- Do not transport the appliance without the transit packaging/bolts/bar in place. Transporting the appliance without the transport packaging/bolts/bar in place may cause damage to the product.
- Never lift the appliance by the door.
- The appliance is heavy, care must be taken when moving it.

Removing Transit Packaging

Important! Ensure all transit packaging is removed prior to installation. Retain transit packaging for future use.

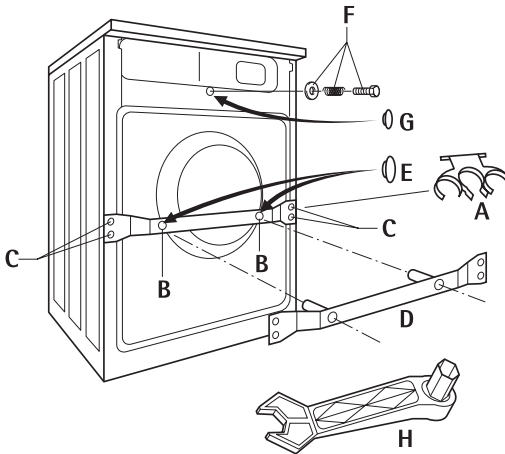

i The appliance is supplied with a spanner (H) and plastic caps (E) (2 pcs.) and (G) (1 pc).

- 1.** Remove the hose holder (A).
- 2.** Remove the 2 screws (B) with the spanner supplied (H).
- 3.** Remove the 4 screws (C).
- 4.** Remove the transit bar (D).
- 5.** Cover the holes left by screws (B) the 2 plastic caps (E).

Important: When fitting the plastic caps, press until they snap into the rear panel securely.

- 6.** Replace the 4 screws (C), for safe keeping.
- 7.** Remove the screw and compression spring (F) with the spanner (H), cover the hole with plastic cap (G).

Important: When fitting the plastic cap, press until they snap into the rear panel securely.

Installation-Site Preparation

- The installation surface must be clean, dry and level.
- Do not install on deep pile carpet.
- If the appliance is installed next to heat source (e. g. cooking appliance), a heat insulating pad (85 x 57 cm) must be placed between the washing machine and the heat source.
- Do not install the appliance in locations where the temperature may fall below freezing.
- Please ensure that when the appliance is installed it is easily accessible for the engineer in the event of a breakdown.

Installation on a Suspended Floor

Suspended wooden floors are particularly susceptible to vibration. To help prevent vibration we recommend you place a waterproof wood panel, at least 15 mm thick under the appliance, secured to at least 2 floor beams with screws. If possible install the appliance in one of the corners of the room, where the floor is more stable.

Levelling the Appliance



Self adjusting foot: The back right foot of your washing machine is designed like a spring leg. This makes the machine very stable even at high spin speeds.

If the washing machine is not stable proceed as follows:



1. Set the three adjustable feet to length of 10 mm. Use the supplied spanner.

If the self adjusting foot does not reach to the floor:

2. Manually extend the self adjusting foot to the required length.
3. Check the appliance is level using a spirit level.

Important! Never use strips or shims of wood or cardboard etc. to compensate for any unevenness in the floor. Always use the adjustable feet.

Electrical Connection

Any electrical work required to install this appliance should be carried out by a qualified electrician or competent person.



WARNING - THIS APPLIANCE MUST BE EARTHED.

The manufacturer declines any liability should these safety measures not be observed.

Before switching on, make sure the electricity supply voltage is the same as that indicated on the appliance rating plate. The rating plate is located at the top of the rim of the open door.

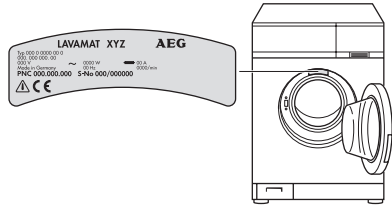

The appliance is supplied with a 13amp plug fitted. In the event of having to change the fuse in the plug supplied, a 13amp ASTA approved (BS 1362) fuse must be used.

Should the plug need to be replaced for any reason. The wires in the mains lead are coloured in accordance with the following code:

Green and Yellow	: Earth
Blue	: Neutral
Brown	: Live

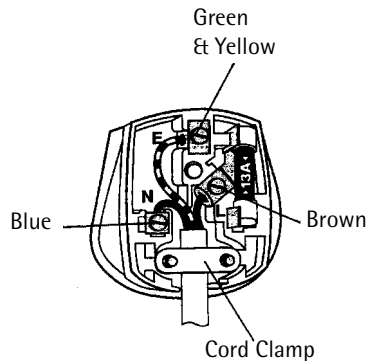

- The wire coloured green and yellow must be connected to the terminal marked with the letter "E" or by the earth symbol \oplus or coloured green and yellow.
- The wire coloured blue must be connected to the terminal "N" or coloured black.
- The wire coloured brown must be connected to the terminal marked "L" or coloured red.
- Upon completion there must be no cut, or stray strands of wire present and the cord clamp must be secure over the outer sheath.



WARNING! A cut off plug inserted into a 13 amp socket is a serious safety (shock) hazard. Ensure that the cut off plug is disposed of safely.

Permanent Connection

In the case of a permanent connection it is necessary that you install a double pole switch between the appliance and the electricity supply (mains), with a minimum gap of 3 mm between the switch contacts and of a type suitable for the required load in compliance with the current electrical regulations.

The switch must not break the yellow and green earth cable at any point.



This appliance is in accordance with the following EU Guidelines:
– Low Voltage Guidelines 73/23 EEC dated 19 February 1973, include Guideline Change Notice 93/68 EEC
– EMC Guideline 89/336 EEC dated 3 May 1989, including Guideline Change Notice 92/31 EEC.

This appliance complies with the requirements laid out in the EEC Directive 76/899.

Voltage 240 V AC Fuse rating 13 amps

See rating plate for further information.

This appliance meets VDE requirements.

Particular regulations of local electricity authorities must be observed. This appliance conforms to EEC Directive No. 82/499/EWG on radio interference.



WARNING! Repairs to electrical appliances must only be carried out by trained personnel. Improper repairs may lead to serious risks for the user.

Water Connection



The washing machine is provided with safety devices preventing back-contamination of the water supply and complies with local water authority requirements.

This appliance is designed to be permanently plumbed into your home's water supply.

Before connecting up the machine to new pipework or to pipework that has not been used for some time, run off a reasonable amount of water to flush out any debris that may have collected in the pipes.

Water Pressure

The appliance is designed to operate within the following water pressure limits:

- minimum 1 bar (14.5 p. s. i.)
- maximum 10 bar (145 p. s. i.)

IMPORTANT!

- At more than 10 bar (145 p. s. i.): Install pressure-reducing valve.
- At less than 1 bar (14.5 p. s. i.): Unscrew the inlet hose from the appliance at the inlet solenoid valve and remove the flow regulator (to do this, remove the sieve with needle-nose pliers and remove rubber washer behind the sieve). Replace sieve. Retain the washer for future use.

Inlet Hose Connection

Important! This appliance must be connected to the cold water supply only.

The inlet hose provided is 1.2 or 1.3 metres depending on the model. If a longer inlet hose is required contact your AEG Service Force Centre. Under no circumstances should hoses be connected together to provide a longer length.

The rubber washers are either set into the inlet hose threaded connection or supplied separately in the installation kit. These washers must be fitted to ensure water tight seals. Do not use any other washer.

-  **1.** Connect the hose to the machine with the right angled connector.

Important! Do not overtighten the plastic nuts on the threaded connectors.

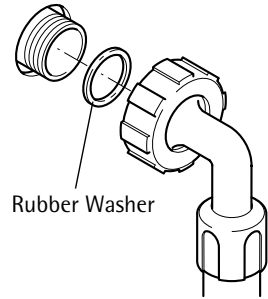

- 2.** Connect the hose end with a straight connector to the water supply tap with an 3/4" thread.

Important! Do not overtighten the plastic nuts on the inlet hose threaded connectors.

WARNING!

Open the water taps slowly and check the connections are watertight before final positioning of the machine.

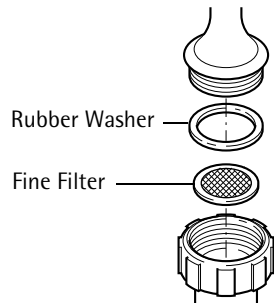

Water Drainage

The appliance drain hose should hook into a standpipe, the hook in the drain hose is formed using the plastic "U-Piece" supplied. The standpipe should have an internal diameter of approximately 38 mm (see diagram) thus ensuring there is an air break between the drain hose and standpipe.

When discharging into a standpipe ensure that the top of the curve in the hose end is no more than 90 cm (35.4") and no less than 60 cm (23.6") above floor level.

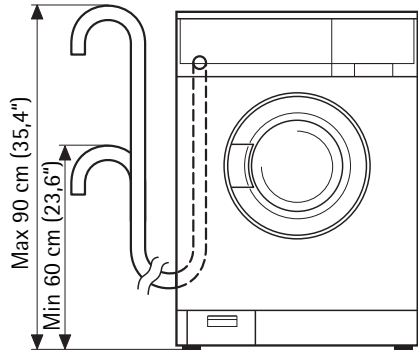

The upright standpipe should have a minimum, length of 30 cm (12") from the bottom of the elbow to the top of the pipe (see diagram). Make sure that it is designed in such a way that the end of the drain hose cannot be covered with water. Longer drain hoses are available in lengths of 2.7 and 4 metres from your AEG Service Force Centre.

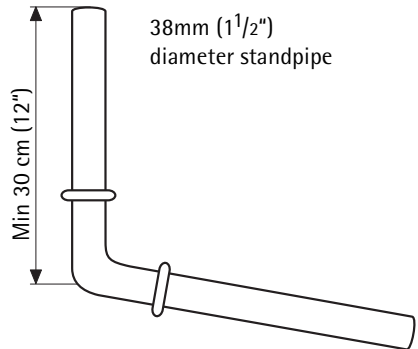

If you intend the drain hose from the washing machine to empty into a sink, make sure that the sink is empty and the plug hose is not blocked. Use the plastic "U-Piece" supplied.

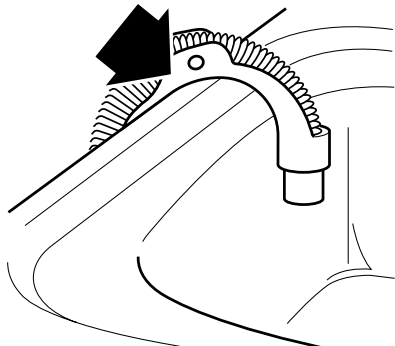

Technical Data

Height x Width x Depth	85x60x60 cm
Depth with open door	95 cm
Height adjustment	approx. +10/-5 mm
Weight when empty	approx. 85 kg
Load (depending on the program)	max. 5 kg
Area of use	Household
Wash cycle drum speed	max. 53 min ⁻¹ r.p.m.
Spin cycle drum speed	see rating plate
Water pressure	1-10 bar (=10-100 N/cm ² = 0.1 - 1.0 MPa)

AEG Service Force

If you wish to contact your local AEG Service Force Centre for advice or spare parts, telephone:

0870 5 929 929

INDEX

A

Additional rinse 34

C

Conditioner 14, 16, 21

liquid 9, 21

Cottons 10, 14, 25, 26

Customer care 37

D

Danger of freezing 6, 32

Delay timer 10, 20, 22

Delicates 11, 14, 25, 26

Detergent 9, 14, 15, 16, 17, 21

liquid 16, 21

Door

opening 20, 24, 30, 34

unlocking in an emergency 34

Drain pump 9, 33

E

Easy-cares 10, 14, 25, 26

Energy saving 10, 25

F

Fabric softener 9, 16, 17, 21, 26

G

Guarantee 6, 28, 38

H

Hand Washing 11, 25, 26

L

Limescale 31

Linen 10, 14, 25, 26

Liquid detergent 16, 21

M

Multi-display 10, 20, 22, 23, 28, 37

N

Net curtains 14, 25

O

ÖKO lock 33

Open door 20, 24, 30, 34

Overdosing 10, 24

P

Pre wash 11, 19, 21, 25

Program progress display 23

Q

Quick wash 12, 19, 25

R

Rating plate 9, 37, 45, 46

Rinse + 34

Rinse hold 10, 19, 24

S

Self adjusting foot 9, 44

Service & Spare Parts 37

Silk 11, 14

Soaking 9, 11, 19, 20, 21, 25

Spin 10, 11, 19, 23, 26

Stains 8, 9, 12, 19, 21, 25, 31

Starch 9, 21

Starching 26

Stopping the Program 23

U

update 12

W

Washing

coloured 13

delicate 11, 13, 14

easy-care 10, 14, 25

gentle rinse 11, 26

insufficiently clean 31

lightly soiled 12, 17

normally soiled 8

powder 16

powder residues 31

starching 11

Water

hardness 17

pump out 11, 24

softening agent 9, 17, 21

wash-water cooling 34, 35

Woollens 11, 14, 25, 26

hand washable 11, 25

AEG Hausgeräte GmbH
Postfach 1036
D-90327 Nürnberg

<http://www.aeg.hausgeraete.de>

© Copyright by AEG

822 942 027 - 01 - 0998